

USER MANUAL

FAULT LOOP IMPEDANCE METER

MZC-340-PV

Icons representing signal strength (green, blue, red), battery level (yellow sun), and communication status (Wi-Fi and speech bubbles).

$U \geq 50 \text{ V}$

Icons representing a battery and a lightning bolt.

12 V

Icons representing pliers, a battery, and a laptop.

Diagram showing the device in its carrying case with arrows indicating opening and closing.

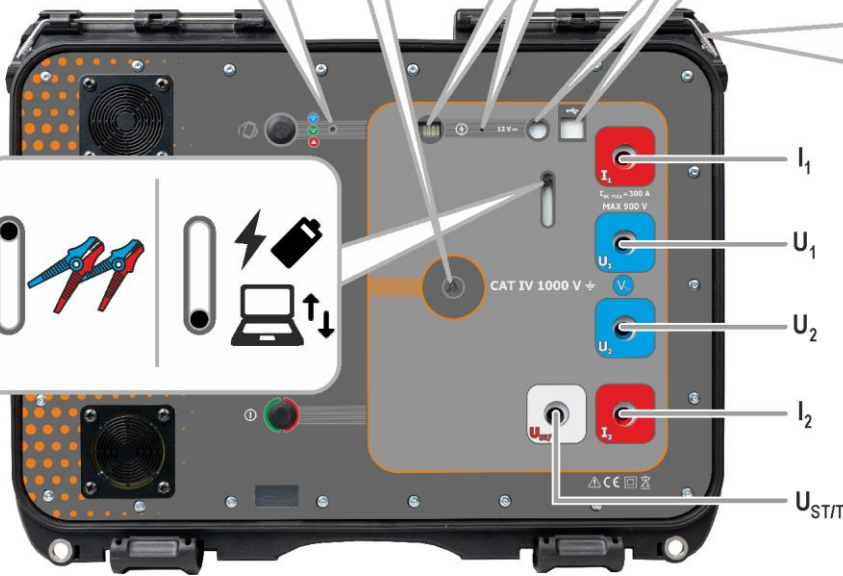



USER MANUAL

FAULT LOOP IMPEDANCE METER MZC-340-PV



**SONEL S.A.
Wokulskiego 11
58-100 Świdnica
Poland**

Version 1.03 20.01.2025

The MZC-340-PV meter is a modern, top quality measuring instrument which is easy and safe to use, provided that the principles presented in this manual are observed. In addition, becoming acquainted with the manual will help you avoid measuring errors and will prevent any possible problems with the operation of the meter.

CONTENTS







1	General information	5
1.1	Safety symbols	5
1.2	Behaviour of signalling LEDs	5
1.3	Safety	6
2	Quick start	7
3	Interface and configuration	8
3.1	Buttons on the housing	8
3.2	Calling the network interface	9
3.2.1	Access Point operation mode	9
3.2.2	Working in a foreign wireless network	10
3.2.3	Working with a control device operating in hotspot mode	12
3.3	Network interface	13
3.3.1	Menu icons	13
3.3.2	Home page	13
3.3.3	Data	13
3.3.4	Settings	13
3.3.5	Help	14
3.3.6	Language selection	14
4	Measurements	15
4.1	Before you start	15
4.1.1	Conditions for performing tests and obtaining correct results	16
4.1.2	Connections for AC voltage measurements	17
4.1.3	Connections for Zs measurements	17
4.1.4	Displaying the measurement results in terms of impedance or short-circuit current	20
4.2	AC voltage	21
4.3	Measurement of fault loop parameters – 4-pole method	22
5	Memory of the meter	24
5.1	Saving measurement result data to the memory	24
5.2	Memory browsing	25
5.3	Memory erasing	25
6	Data transmission	26
6.1	Set of accessories to connect the meter to a PC	26
6.2	Data transmission through USB	26
6.3	Data transmission through Wi-Fi	27
7	Software update	28
8	Troubleshooting	29
8.1	Warnings and information displayed by the meter	29
8.1.1	Exceeding the measurement range	29
8.1.2	Battery status	29
8.2	Self-test error messages	29
8.3	Before you send the device for repairs	30
9	Power supply	31
9.1	Power supply voltage monitoring	31

- 9.2 Battery power 31
- 9.3 Charging rechargeable battery 32
- 9.4 General rules for using Li-Ion rechargeable batteries 33
- 10 Cleaning and maintenance 34**
- 11 Storage..... 34**
- 12 Dismantling and utilisation 34**
- 13 Technical data 35**
 - 13.1 Basic data 35
 - 13.1.1 Measurement of voltage (True RMS) 35
 - 13.1.2 Measurement of frequency..... 35
 - 13.1.3 Measurement of short-circuit loop parameters using high current (Z_s – 4-pole method, $I_{max}=305$ A)..... 35
 - 13.2 Other technical data 37
 - 13.3 Additional data 38
 - 13.3.1 Additional uncertainties according to IEC 61557-3 (Z)..... 38
- 14 Manufacturer 38**

1 General information

1.1 Safety symbols

The following international symbols are used in the device and/or in this manual:

	Refer to the user manual for additional information and explanations		Ground		AC current/voltage
	DC current/voltage		Double insulation (protection class)		Declaration of Conformity with EU directives (<i>Conformité Européenne</i>)
	Do not dispose of with other household waste				

Measurement categories according to EN IEC 61010-2-030:

- **CAT II** – concerns measurements performed in circuits directly connected to low voltage installations,
- **CAT III** – concerns measurements performed in buildings installations,
- **CAT IV** – concerns measurements performed at the source of low voltage installation.

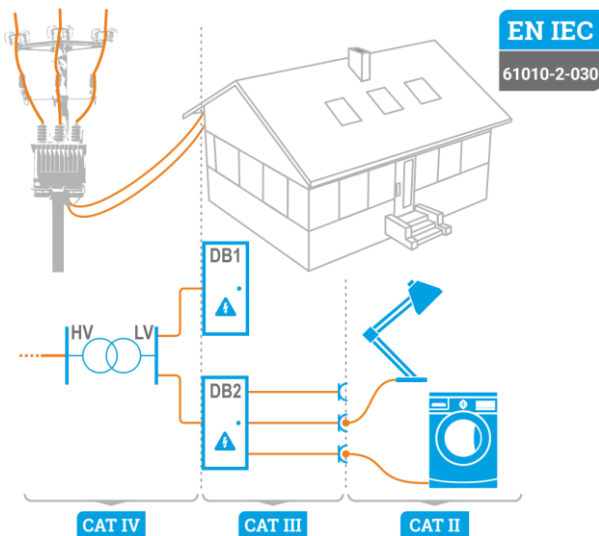

1.2 Behaviour of signalling LEDs



The LED is on continuously



The LED flashes slowly



The LED flashes rapidly

1.3 Safety

The MZC-340-PV meter is designed for performing inspection tests for protection against electric shock in mains systems. The meter is used for making measurements and providing results to determine safety of electrical installations. Therefore, in order to provide the conditions for correct operation and accuracy of obtained results, the following recommendations must be observed:

- Before you proceed to operate the meter, acquaint yourself thoroughly with the present manual and observe the safety regulations and recommendations of the manufacturer.
- Any application that differs from those specified in the manual may result in damage to the device and constitute a source of danger for the user.
- The meter must only be operated by appropriately qualified personnel with relevant certificates authorising the personnel to perform works on electric systems. Unauthorized use of the meter may result in its damage and may be a source of serious hazard to the user and bystanders.
- Using this manual does not exclude the need to comply with occupational health and safety regulations and with other relevant fire regulations required during the performance of a particular type of work. Before starting the work with the device in special environments, e.g. potentially fire-risk/explosive environment, it is necessary to consult with the person responsible for health and safety.
- It is unacceptable to operate:
 - ⇒ it is damaged and completely or partially out of order,
 - ⇒ its cords and cables have damaged insulation,
 - ⇒ it was stored for an excessive period of time in disadvantageous conditions (e.g. excessive humidity) After moving the device from a cool to a warm place with a high level of relative humidity, do not start measurements until the device is warmed up to the ambient temperature (approximately 30 minutes).
- Before measurement, choose a correct measurement function and make sure that the test leads are connected to their respective measuring terminals.
- The correct operation of the instrument and accessories must be checked regularly to avoid any hazard which may result from erroneous results.
- In a situation where the product works with other instruments or accessories, the lowest measurement category of the connected devices is used.
- Do not power the meter from sources other than those listed in this manual.
- Repairs may only be performed by an authorised service point.



WARNING

Only accessories for a given device should be used. Using other accessories may cause damage to measuring terminals, introduce additional measurement error and create a risk for the user.



Due to continuous development of the meter's software, the actual appearance of the display for some features may slightly differ from that presented in this user manual. The latest version of the manual is provided on the manufacturer's website.

2 Quick start

1



Turn the meter on.

2

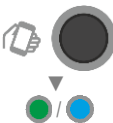

Switch the meter to Access Point mode (●) or foreign wireless network mode (●).

3



Connect your control device (tablet, smartphone, laptop, etc.) to the network broadcast by the meter or the network in which the meter operates.

4



Call up the meter's network interface.

5



Enter the meter settings.

6



Enter the measurement settings.

7



Connect the meter to the tested object.

8



Start the measurement.

9



Save the result in the memory.

10



Turn the meter off.

3 Interface and configuration

3.1 Buttons on the housing

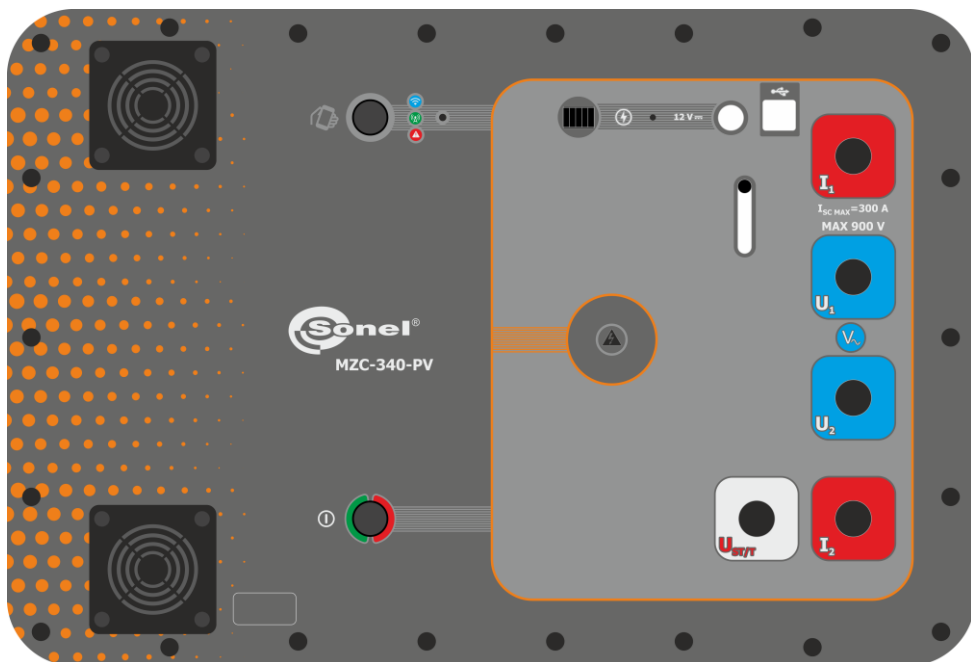

- Turn on the meter (short press)
- Turn off the meter (press and hold)



Data transmission to and from the device:

- directly – access point
- indirectly – foreign wireless network





Shutter switch: 12 V and USB socket/test lead sockets available

3.2 Calling the network interface

3.2.1 Access Point operation mode

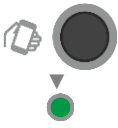
In the Access Point (AP) mode, the meter emits its own wireless network to which a control device must be connected in order to activate the network interface. This network does not have access to the Internet, so neither will the control device.

-  Turn the meter on.
-  Switch the meter to AP mode. From now on, the meter emits its own Wi-Fi network called: **MZC-340-PV_MeterSerialNumber**.
-  Connect your control device to the network emitted by the meter. Network password: **mzc340pv**.
-  Enter the address assigned to the meter into your web browser.
 - If you have a device with Windows 11, IOS, Android 12 or newer (supports mDNS), enter: **mzc-340-pv_MeterSerialNumber.local**.
 - In other cases, enter: **192.168.4.1**.

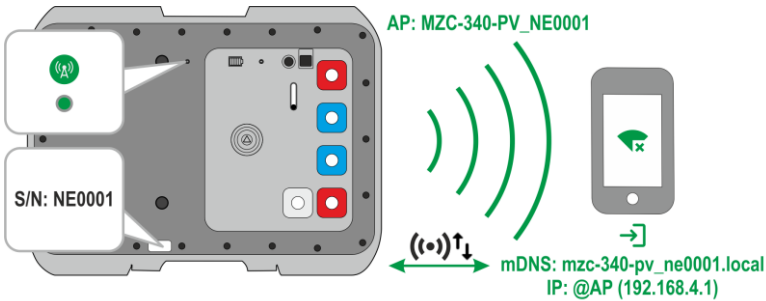

Additional information displayed by the meter

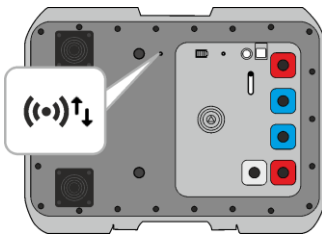

The access point is being established



Access point established



Error occurred

3.2.2 Working in a foreign wireless network

The meter and the control device on which its interface is to be called up can be logged in to a foreign wireless network. If this network has access to the Internet, the control device will also have it. However, the first configuration requires that the interface be called up in the Access Point (**AP**) mode.

1



Turn the meter on.

2



Switch the meter to AP mode. From now on, the meter emits its own Wi-Fi network called: **MZC-340-PV_MeterSerialNumber**.



Set the rule in the control device that it should connect automatically to the network emitted by the meter as soon as it appears. This is important due to **step 5** (the meter must exit and then re-enter AP mode, i.e. the network emitted by it will disappear for some time).

3



Connect your control device to the network emitted by the meter. Network password: **mzc340pv**.

4



Enter the address assigned to the meter into your web browser.

- If you have a device with Windows 11, IOS, Android 12 or newer (supports mDNS), enter: **mzc-340-pv_MeterSerialNumber.local**.
- In other cases, enter: **192.168.4.1**.

5



Go to **Main menu ► Settings ► Wi-Fi** and select the foreign network to which the meter should connect. Select **Search Wi-Fi**.

- If the network is saved in the meter's memory, select it from the list and enter its password. Select **Connect**. The meter will exit AP mode, log in to the foreign network for a short time, and then return to AP mode. The **IP address** assigned by the network to the meter will appear on the screen.
- If the network is not in the meter's memory, select **+ Add another network** and enter its name and password. Select **Connect**. The meter will exit AP mode, log in to the foreign network for a short time, and then return to AP mode. The **IP address** assigned by the network to the meter will appear on the screen.

6



Switch the meter to the mode of operation in a foreign wireless network (button or **Settings ► Wi-Fi ► Change mode**).

7



Connect the control device to a foreign network and enter the address that is assigned to the meter into a web browser.

- If you have a device with Windows 11, IOS, Android 12 or newer (supports mDNS), enter: **mzc-340-pv_MeterSerialNumber.local**.
- In other cases, enter the **IP address** that the network assigned to the meter (manually or via the QR code obtained in the **Wi-Fi** section).

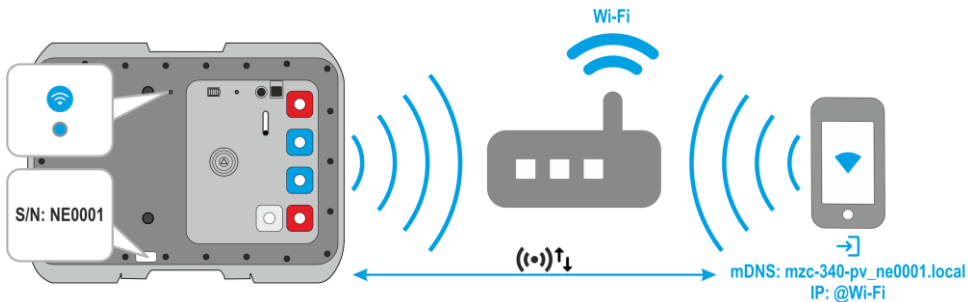

- To check the IP of the meter when it works in a foreign network:
 - switch the meter to access point mode,
 - go to **Main menu ► Settings ► Wi-Fi**.

Saved Wi-Fi is a foreign network in which the meter will work, and **IP** is the IP address that has been assigned to it. You will also get it in the form of a QR code after selecting the **QR code** button.
- After restarting, the meter automatically enters the mode of operation in a foreign network.
- After restarting, the meter will automatically connect to the last network saved in it.

Additional information displayed by the meter

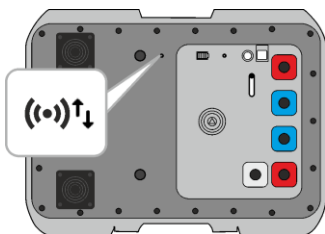

The meter logs into a foreign network











The meter is logged into a foreign network



Error occurred

3.2.3 Working with a control device operating in hotspot mode

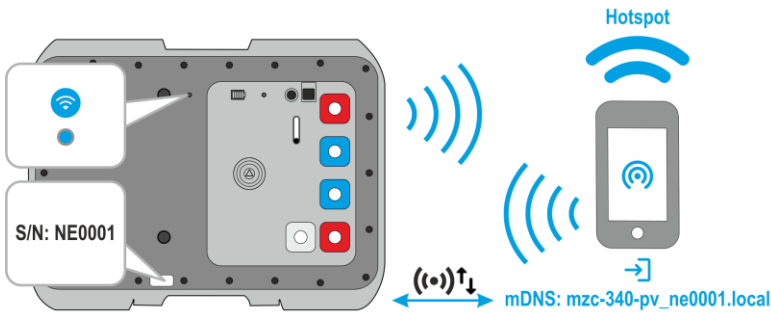

The meter can be logged in to the hotspot generated by the control device. Internet access depends on whether the hotspot has data transmission enabled.

-   Turn the meter on.
-   Switch the meter to AP mode or operation mode in a foreign wireless network and call up its network interface.
-   Go to **Settings** ► **Wi-Fi** and select **Add Your Hotspot**.
 - Enter the name and password of the hotspot you want the meter to connect to.
 - Select **Connect with hotspot**.
-   Within 15 seconds, turn on the hotspot on the control device. The meter will automatically switch to it after this time.
 - While the countdown is in progress, you can extend the time until the meter switches by 15 seconds by pressing the appropriate button.
 - You can cancel the upcoming switch by pressing the **Cancel** button.

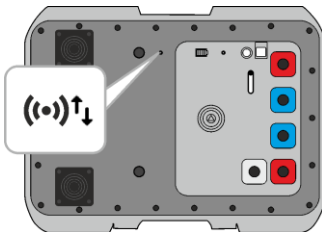

Additional information displayed by the meter



-  The meter logs into a foreign network
-  The meter is logged into a foreign network
-  Error occurred

3.3 Network interface

3.3.1 Menu icons



Expand menu



Select interface language



Close menu

3.3.2 Home page

Here is the measurement screen.

3.3.3 Data

Here you can view the contents of the device's memory.

- **Load all memory** – loading the entire meter memory into the control device. You can then export the downloaded database to a file.
- **Deleting a cell** – here you can move around the meter's memory and delete results from selected banks and memory cells.
- **Delete bank** – here you can delete selected memory banks.
- **Erasing memory** – here you can erase the entire meter memory.

3.3.4 Settings

3.3.4.1 Measurement settings

Available settings:

- **Mains voltage** – here you can configure the nominal mains voltage U_n .
- **Zs measurement** – here you can enable the measurement of touch voltage U_{ST} , touch shock voltage U_T or leave the default result. This value is related to the expected short-circuit current calculated according to the formula presented in **sec. 4.1.4**. The U_{ST} or U_T value is displayed at the end of the measurement result list.



The measurement of touch shock voltage U_T is performed after introducing a 1 k Ω additional resistor (inside the device) between the terminals U_2 and U_{STT} . The resistor simulates resistance of the human body, while the terminal U_{STT} is to be connected to the probe that simulates human feet located on the ground, whose properties and load are described by relevant standards.

3.3.4.2 Data transmission

Available settings:

- **Wi-Fi transmission** – here you will allow data transmission between the meter and the computer via the wireless network.

3.3.4.3 Wi-Fi

Here you can manage wireless networks saved in the meter's memory and check its IP in a given network.

- **Change mode** – here you can switch the meter's operating mode (access point / operation in a foreign network).
- **Disconnect** – here you can disconnect the meter from the network to which it is currently logged in.
- **Search Wi-Fi** – here you can see a list of all networks saved in the meter. The meter only remembers their names. Select the network in which the meter is to work, enter its password and select **Connect**.
 - **+ Add another network** – here you can add a network that is not detected by the meter.
- **Add Your Hotspot** – here you can connect the meter to the hotspot. See **sec. 3.2.3**.
- **QR code** – here you will get a QR code with the current IP address of the meter when it works in a foreign wireless network.

3.3.4.4 Updates

Here you can check the meter's software version and update it. See also **sec. 7**.

3.3.5 Help

Here you will find answers to key issues and information about the manufacturer.

3.3.6 Language selection

In the upper right corner you will see an icon with the currently set interface language. Tap it to bring up the language change menu.

4 Measurements



WARNING

- During measurements, the earthed parts and parts accessible in the electrical installation being tested must not be touched.
- Connecting unsuitable or faulty cables can cause an electrical shock.
- You must not leave disconnected leads while some of them remains connected to the tested installation.
- You must not leave the device unattended while it is connected to the tested installation.
- You must not touch appliances connected to the tested installation.



NOTE!

Connecting voltage higher than 900 V between any of the test terminals may damage the meter.



- Performing a large number of consecutive measurements in short intervals can cause the resistor limiting the current flowing through the device to produce large amounts of heat which in turn can cause the device's housing to become hot. This is quite normal. The device has a built-in overheating protection.
- During measurements with a current of an order of 300 A, the instrument, if necessary, activates a fan that reduces the instrument cool-down time.
- The minimum time interval between successive measurements is 5 seconds. The text **READY** displayed on the screen informs the user that the device is ready to perform the measurement

4.1 Before you start



- The manufacturer guarantees correct readings only if the original leads supplied with the device are used. Extension leads or third party cables can be a source of additional errors.
- If the tested installation includes RCD circuit breakers, you should bridge them for the duration of the test. You should keep in mind however that doing so you modify the tested circuit and consequently the results can marginally differ from the expected results.
- **Remember to remove any modifications of the installations** that were introduced and check the functioning of the RCD circuit breakers.
- Attention should be paid to the correct selection of test terminals since the precision of the measurements being performed depends upon the quality of connections made. They have to provide a good contact and allow for undisturbed flow of high current measured. For instance, it is unacceptable to clip the crocodile connectors onto oxidized or corroded points – they have to be either cleaned beforehand, or the test needle tip probe should be used for measurements.

4.1.1 Conditions for performing tests and obtaining correct results

To start a test sequence a number of conditions have to be fulfilled. The device will automatically prevent a test from commencing (except for voltage measurement) if any of the conditions listed below is not satisfied.

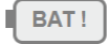
Symptom	Cause	Action
U > 900 V! + continuous beep	The voltage applied to meter's terminals exceeds 900 V.	Immediately disconnect the meter from the tested installation!
Error! f < 45 Hz or f > 65 Hz + two long beeps	The voltage frequency in the installation is outside of the range 45 Hz...65 Hz.	The text appears and a sound signal is produced when the measurement is started.
Error! U- < 200 V + two long beeps	The voltage applied to meter's terminals is too low to measure the impedance.	The text appears and a sound signal is produced when the measurement is started.
No voltage on terminals I1, I2! + two long beeps	Improperly connected lead I1 or I2.	The text appears and a sound signal is produced when the measurement is started.
Different voltage phases on terminals U and I! + two long beeps	Leads U or I swapped, or connected to different phases.	The text appears and a sound signal is produced when the measurement is started.
Incorrectly connected cable! Terminal U_{ST/I}! + two long beeps	Improperly connected lead U _{ST/I} with the set option of touch voltage measurement.	The text appears and a sound signal is produced when the measurement is started.
Voltage failure while measuring! + two long beeps	While measuring the loop impedance a voltage drop below U _{min} took place.	
Error while measuring! + two long beeps	While measuring the loop impedance a situation preventing completion of the measurement occurred.	
Short circuit loop faulty! + two long beeps	While measuring the loop impedance the fuse was burnt or another emergency situation in the current circuit occurred.	
 + beep	Thermal protection prevents the measurement.	A sound signal is produced when the measurement is started.
	Discharged battery.	Making the measurements is still possible, however, the user should take into account some additional errors.



Displayed warnings stay on the screen for 3 seconds.

4.1.2 Connections for AC voltage measurements

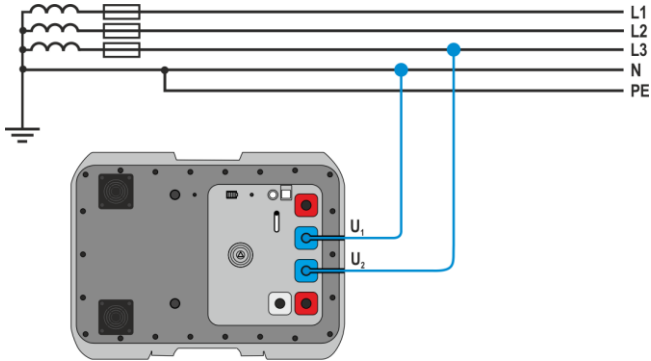

Alternating voltage measurement.

4.1.3 Connections for Z_s measurements

4.1.3.1 Measurement of touch voltage U_{ST} and shock voltage U_T

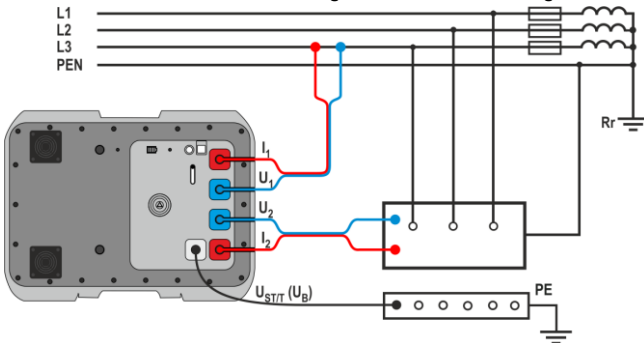

Measurement of touch voltage U_{ST}.

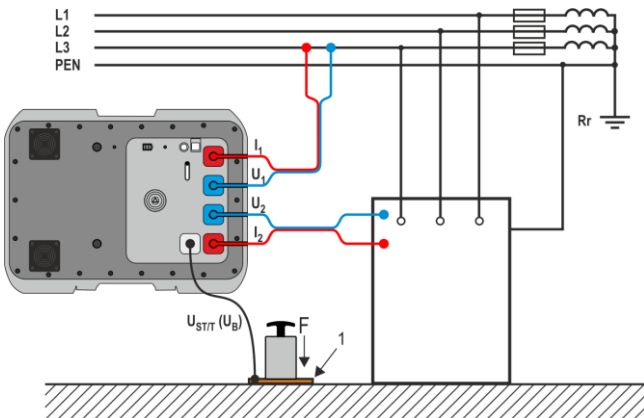

Measurement of shock voltage U_T.
1 – probe.

4.1.3.2 Measurement of short-circuit loop parameters – 4-pole method

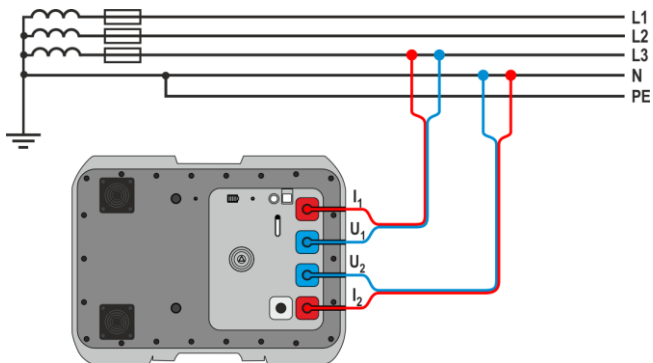

Measurement of impedance in working circuit (L-N).

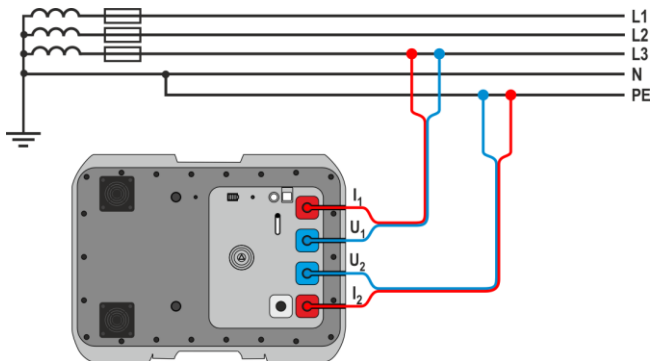

Measurement of impedance in protective circuit (L-PE).

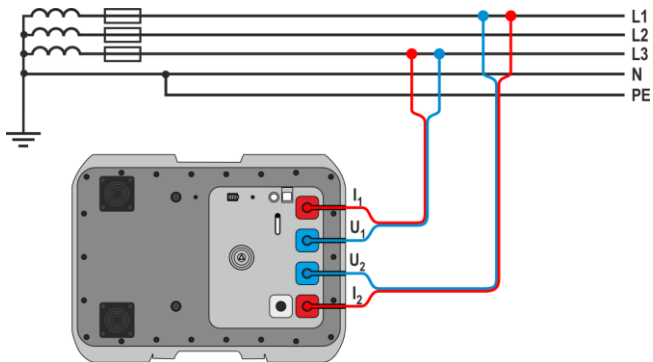

Measurement of impedance in working circuit (L-L).

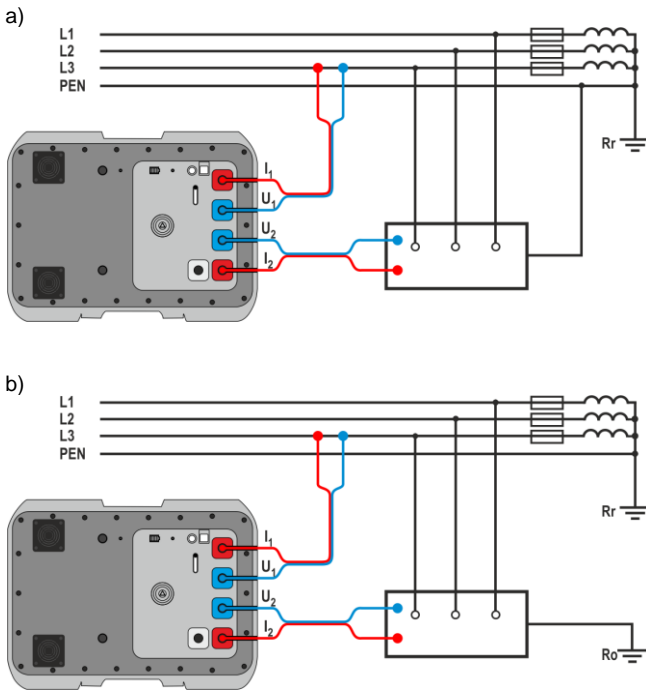

Verification of anti-shock protection reliability of appliance's housing for:
 a) TN network,
 b) TT network.

Impedance measurement in the working circuit (L1-L2) of an IT mains on the example of a photovoltaic farm with an 800 V AC IT mains.

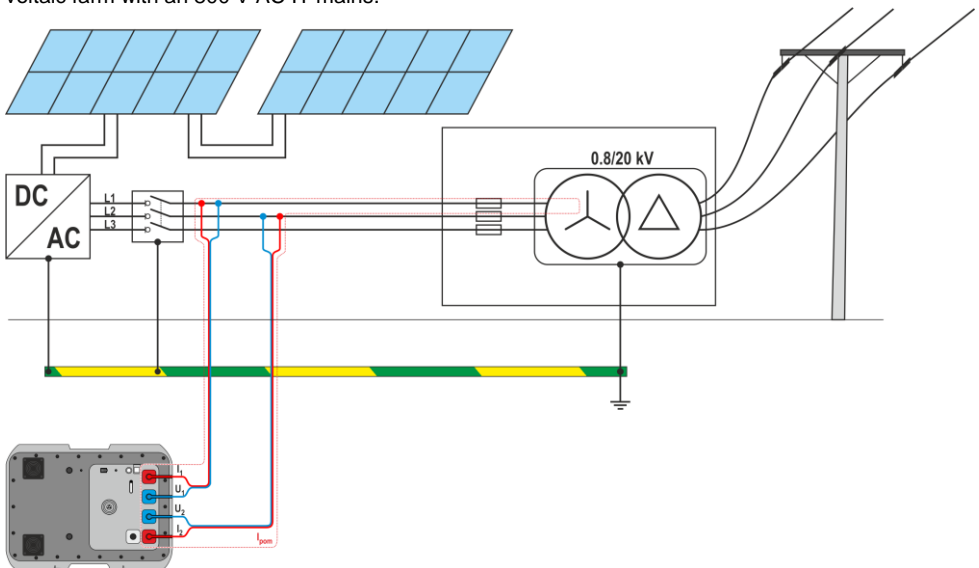

4.1.4 Displaying the measurement results in terms of impedance or short-circuit current

The main measurement result is displayed as short-circuit loop impedance and short-circuit current. The device always measures impedance, and the short-circuit current displayed is calculated from the formula:

$$I_k = \frac{U_n}{Z_s}$$

where:

U_n – rated voltage of the network being tested,
 Z_s – impedance measured.

The meter automatically recognizes the measurement for line voltage and takes it into account in calculations.

In a case when the installation voltage is outside of tolerance, the meter will not be able to determine the rated voltage for the short-circuit current calculation. In such event the display will show horizontal dashes instead of the short-circuit current value. Fig. 1 shows voltage ranges for which the short-circuit current is calculated.

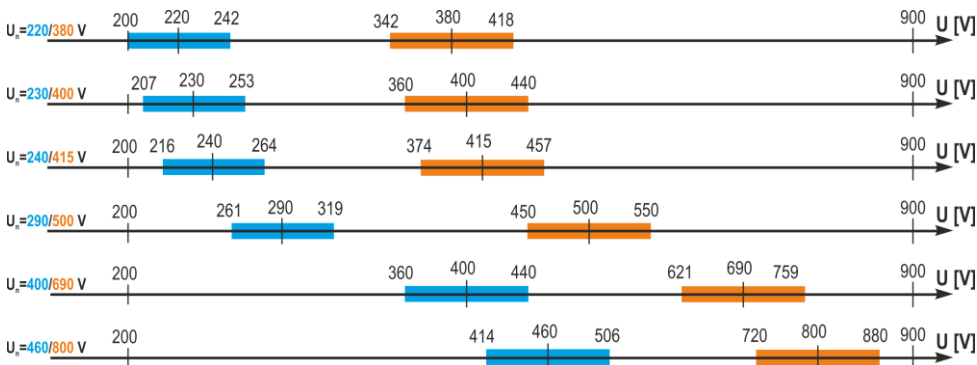

Fig. 1. Relationship between the network voltage and the ability to calculate the short-circuit current

- █ – the U_{n-N} voltage ranges, for which the network's U_n is identified and the short-circuit current is calculated
- █ – the U_{n-L} voltage ranges, for which the network's U_n is identified and the short-circuit current is calculated
- 200 V...900 V – The voltage range for which the impedance measurement is performed

Further in this document the term „impedance measurement” will refer to performing the measurement and displaying the result in terms of current or impedance.

4.2 AC voltage



NOTE!

Applying voltage in excess of 900 V to any of the test terminals may damage the meter.

1



Select **Voltage measurement**.

2

Connect test leads according to **sec. 4.1.2**.

3

Read the result – the measurement is performed continuously.

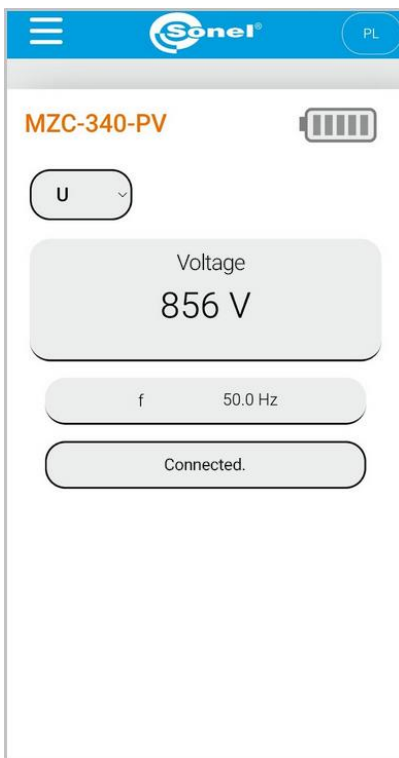

- The instrument measures alternating voltage with the frequency within range 45 Hz...65 Hz as True RMS without separating a possible constant component. Voltage with the frequency lower than 45 Hz is measured as direct voltage.
- If the frequency of the signal being measured is not included within the specified limits, instead of its value an appropriate message is displayed: **f < 45 Hz** or **f > 65 Hz**.

4.3 Measurement of fault loop parameters – 4-pole method



WARNING

Use caution when operating the device as hot air that can be expelled by the built-in fans.

This is a measurement involving the current with a value of approx. 300 A. It is specifically designed for circuits with very low short-circuit loop impedance. After measurement, the following results are displayed:

- Z_s – fault loop impedance
- I_k – short-circuit current,
- f – mains voltage frequency (current reading),
- U – value of the mains voltage at the moment of measurement (current reading),
- R – fault loop resistance,
- X_L – fault loop reactance.

1



Settings

Go to the **Settings** ► **Measurement settings** and set the rated network voltage and the type of voltage to be measured.

2



Select **Impedance measurement**.

3

Connect test leads according to **sec. 4.1.3**.

4

Unlock the measurement.



5



Start the measurement.

6

After the measurement is completed, read the result.

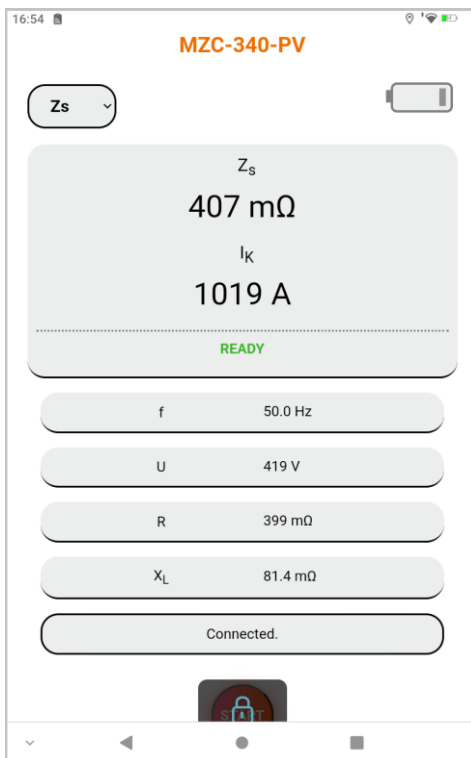

7

Save results

Save the result in the memory of the meter.



- If touch voltage is not measured, the user should go to **Settings** and select the „-“ option. Otherwise the displayed values will not be correct since they can induce interfering voltages in unconnected socket $U_{ST/T}$.
- The touch shock voltage U_T measured by the meter refers to the nominal network voltage that was selected in the settings and at which the measurement was performed. For other rated voltages the result displayed should be converted.

5 Memory of the meter

The meter has a built-in memory for storing up to 990 results of short-circuit loop parameters. A location in the memory where a single result is stored is called a memory cell. The whole memory is divided into 10 banks, each consisting of 99 cells. Every result can be stored in a cell with a specific address and in a selected bank. In this way the user can allocate the cell numbers to individual measuring points and the bank number to particular objects, make measurements in any sequence and repeat them without losing the other data.

The results storage is not erased when the meter is switched off. The data can be therefore retrieved at a later time or transferred to a computer. The address of the current cell or bank number does not change either.

It is recommended to erase the memory after the data has been read or before making a new series of measurements that can be stored to the same cells as the previous ones.

5.1 Saving measurement result data to the memory

Only the results of measurements made in the **Zs** mode can be saved in the memory.

- 1



Start the measurement.

- 2



Select **Save results**.

- 3



- Select the bank and cell number or leave the current numbers (recommended if the bank was deleted before measurements).
 - If the result is a fault loop value, enter the wire designations between which it was measured.
 - If you have changed your mind about saving, select **X** in the upper right corner of the save window.

- 4



Confirm your selection.
 - **For an empty cell:** the main result and its components, as well as the network voltage and frequency values at the moment of measurement, as well as the nominal network voltage, are saved in the memory.
 - **For a taken cell:** an attempt to make an entry in an already taken cell results in a warning message. Selecting the **Overwrite** command will result in entering a new measurement result and losing the previous one. To cancel the entry and select another, free cell, select **Cancel**.

5.2 Memory browsing

1



Go to the **Data** section.

2



Select **Load all memory**, and then **Update meter data**. The current contents of the meter's memory will be downloaded to the control device. Each bank containing measurement data will have a blue label.

3



Select the bank with cells you want to view. The results list will expand.

4



The **Download the CSV file** command causes all data that was recalled from the meter in the previous step to be downloaded to a CSV file after confirming the command.

5.3 Memory erasing

1



Go to the **Data** section.

2



Select **Load all memory**, and then **Update meter data**. The current contents of the meter's memory will be downloaded to the control device. Each bank containing measurement data will have a blue label.

3



Select the appropriate option.

- **Deleting a cell** – select this option and then select the bank and cell number to delete the contents of this cell. If you have changed your mind, select **×** in the upper right corner of the window.
- **Delete bank** – select this option and then select the bank number to delete the contents of this bank.
- **Erasing memory** – select this option to clear all meter memory.

4

Delete

Select **Delete**. If you change your mind, select **Cancel**.

6 Data transmission

6.1 Set of accessories to connect the meter to a PC

In order to ensure the communication of the meter with a computer a USB cable and the relevant software are required:

- Sonel Reader,
- Sonel Reports PLUS.

The software may be used for many devices manufactured by SONEL S.A. which are equipped with a USB interface. Detailed information is available from the manufacturer and distributors.

If the required software has not been purchased with the meter, it may be obtained from the manufacturer or from an authorised distributor.

6.2 Data transmission through USB

1



Connect the cable to USB port of the computer and to the USB socket of the meter. Remote control of the meter is blocked.

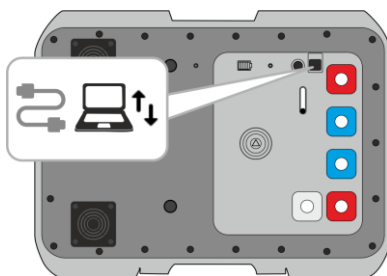

2

Start the software to read/save data and proceed in accordance with its instructions.

3

After disconnecting the cable from the meter, you must wait until it restarts. Remote control will be possible again.

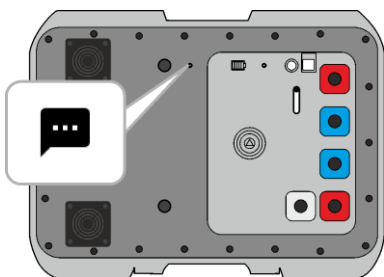

USB communication, data transfer.

6.3 Data transmission through Wi-Fi

1



Connect the meter to a foreign wireless network.

2



Make sure that the software that creates a virtual COM port with port **3333** and **IP address of the meter** is installed in the control device.

3



In the network interface, go to **Data** section and then to **Data transmission ► Wi-Fi transmission**.

4

Start the software to read/save data and proceed in accordance with its instructions.

7 Software update



NOTE!

- Before starting the update, charge the meter battery to 100%.
- Do not turn off the meter while the update is in progress.



The  button is disabled during the update. The meter does not switch off automatically in this function.

1



Connect the meter to a Wi-Fi network with Internet access (**sec. 3.2.2**).

2



Settings

In the network interface go to **Settings ► Updates**.

3



Select **Update**. Follow the displayed instructions.



If necessary, you can restore the previous version of the software. To do this, select **Restore the previous software version** in the menu.

8 Troubleshooting

8.1 Warnings and information displayed by the meter

The meter displays warnings that can be related to either its functioning or to external conditions affecting the measurement processes.

8.1.1 Exceeding the measurement range

Message	Audible signal	Cause	Action
U > 900 V !	Continuous	Voltage measured exceeds 900 V	Immediately disconnect the meter from the network!
OFL	-	Short-circuit loop resistance exceeds 2 Ω	-

8.1.2 Battery status

Message	Cause	Action
	Battery is discharged	Charge the battery

8.2 Self-test error messages

If, as a result of the self-test, the instrument detects an error, it stops the normal operation and displays an error message. The following messages can appear:

- **Internal error**
- **Damaged FLASH kernel!**
- **Damaged calibration data**

The message that appears may be caused by a momentary interference or an external factor. You should therefore switch the device off and then on to determine if this is the case. If the problem persists, the device should be sent to a service agent.

8.3 Before you send the device for repairs

Before you send the device to a service agent, you should contact the technical support to ensure that the problem is a result of a fault and is not caused by some other factors.

The repairs should be carried out only by service agents authorised by the manufacturer.



In the table below you will find the procedures that should be followed in a case of a mal-function.

Symptom	Cause	Action
The meter does not switch on with the ON/OFF button.	Battery may be discharged.	Charge the battery. If the problem persists send the device to the service agent
Consecutive results obtained in the same measuring point differ markedly.	Faulty connection in the installation being tested.	Find and remove faulty connections.
	Installation with a high level of interference or unstable voltage.	Perform more measurements, average the results.
Measurement errors when the device is moved from a cold to a warm and humid environment.	Lack of acclimatization.	Do not use the device until it reaches the ambient temperature (approx. 30 min) and dries out.
The meter shows values close to zero or zero irrespective of the measurement place, and the values deviate considerably from the anticipated values.	Fault in the short circuit loop.	Send the device to a service agent.

9 Power supply

9.1 Power supply voltage monitoring

The battery charge level is constantly displayed:

- on the meter: through the diodes on the housing ,
- in the network interface: by the symbol located in the upper right corner of the measurement screen .

9.2 Battery power

Miernik jest zasilany z akumulatora litowo-jonowego. The meter is powered by a 12 V power supply. It can be also charged from the car 12 V accessory socket, using an optional converter.

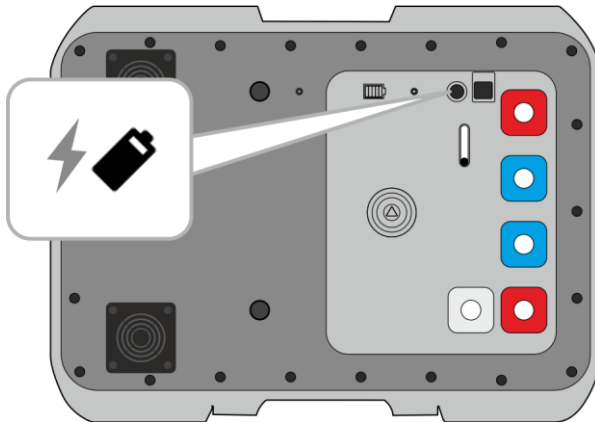

NOTE!

Do not power the meter from sources other than those listed in this manual.

9.3 Charging rechargeable battery

Charging starts once the power supply has been connected to the meter, regardless of whether the meter is on or off. It takes approximately 7 hours to fully charge a completely discharged battery.

When the meter is turned off by  button or by **AUTO-OFF**, the charging process is not stopped.

Indication of completed charging:  (meter) and  (network interface).



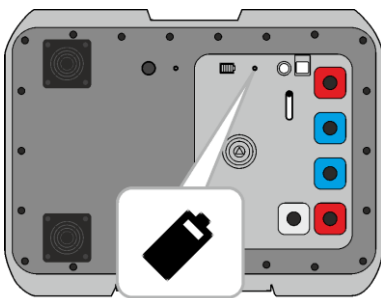

Additional information displayed by the meter



-  Charging in progress.

-  Charging complete

- 
 - Temperature of the battery pack is too low or too high. Charging paused
- 
 - Other charging issues

9.4 General rules for using Li-Ion rechargeable batteries

- Store the meter with batteries charged at least to 50%. The battery pack may be damaged if stored when fully discharged. The ambient temperature for prolonged storage should be maintained within the range of 5°C...25°C. The environment should be dry and well ventilated. Protect the device from direct sunlight.
- Charge the batteries in a cool, well-ventilated place at a temperature of 10°C ... 28°C. Modern fast chargers detect both too low and too high temperature of rechargeable batteries and react to the situation adequately. When the temperature is too low, charging is prevented as it may irreparably damage the batteries.
- Do not charge or use the batteries in extreme temperatures. Extreme temperatures reduce the lifetime of rechargeable batteries. Always observe the rated operating temperature. Do not dispose of the battery pack into fire.
- Li-Ion cells are sensitive to mechanical damage. This kind of damage may cause its permanent damage and thus cause ignition or explosion. Any interference in the structure of Li-ion battery pack may cause its damage. This may result in its ignition or explosion. A short-circuit of the battery poles "+" and "-" may permanently damage the battery pack or even cause its fire or explosion.
- Do not immerse Li-Ion battery in liquids and do not store in humid conditions.
- If the electrolyte contained in the Lithium-Ion battery pack comes into contact with eyes or skin, immediately rinse the affected area with plenty of water and consult with a doctor. Protect the battery against unauthorised persons and children.
- When you notice any changes in the Lithium-Ion battery pack (e.g. changes in colour, swelling, excessive temperature), stop using the battery pack. Li-Ion batteries that are mechanically damaged, overcharged or excessively discharged are not suitable for use.
- Any misuse of the battery may cause its permanent damage. This may result in its ignition. The seller and the manufacturer shall not be liable for any damages resulting from improper handling of the Li-Ion battery pack.

10 Cleaning and maintenance



NOTE!

Use only the maintenance methods specified by the manufacturer in this manual.

The casing of the meter may be cleaned with a soft, damp cloth using all-purpose detergents. Do not use any solvents or cleaning agents which might damage the casing (powders, pastes, etc.).

The test leads should be cleaned with water and detergents, and then dried.

The electronic system of the meter does not require maintenance.

11 Storage

In the case of storage of the device, the following recommendations must be observed:

- disconnect all the test leads from the meter,
- clean the meter and all its accessories thoroughly,
- wind the test leads,
- in order to prevent a total discharge of the battery pack in the case of a prolonged storage, charge the device **at least once every six months**.

12 Dismantling and utilisation

Worn-out electric and electronic equipment should be gathered selectively, i.e. it must not be placed with waste of another kind.

Worn-out electronic equipment should be sent to a collection point in accordance with the regulations valid in a given region.

Before the equipment is sent to a collection point, do not dismantle any elements.

Observe local regulations concerning disposal of packages, waste batteries and rechargeable batteries.

13 Technical data

13.1 Basic data

⇒ The abbreviation "m.v." used in the specification of accuracy denotes a measured value

13.1.1 Measurement of voltage (True RMS)

Measurement range: 0 V...900 V

Display range	Resolution	Accuracy
0 V...249 V	1 V	±(2% m.v. + 4 digits)
250 V...900 V	1 V	±(2% m.v. + 2 digits)

- Frequency range: DC, 45...65 Hz
- Input impedance of the voltmeter: ≥200 kΩ

13.1.2 Measurement of frequency

Display range	Resolution	Accuracy
45.0 Hz...65.0 Hz	0.1 Hz	±(0.1% m.v. + 1 digit)

- Voltage range: ≥50 V

13.1.3 Measurement of short-circuit loop parameters using high current (Z_s – 4-pole method, $I_{max}=305$ A)

Measurement of short-circuit loop impedance Z_s

Measuring range according to EN IEC 61557: 7.2 mΩ...1999 mΩ

Display range for Z_s

Display range	Resolution	Accuracy
0.0 mΩ...199.9 mΩ	0.1 mΩ	±(2% m.v. + 2 mΩ)
200 mΩ...1999 mΩ	1 mΩ	

- Voltage range: 200...900 V

Display range for short-circuit resistance R_s and reactance X_s

Display range	Resolution	Accuracy
0.0 mΩ...199.9 mΩ	0.1 mΩ	±(2% + 2 mΩ) of Z_s value
200 mΩ...1999 mΩ	1 mΩ	

- Voltage range: 200...900 V

Display range for I_k

Measuring range according to EN IEC 61557:

- for $U_n = 230$ V: 115.0 A...32.9 kA
- for $U_n = 400$ V: 200 A...55.5 kA
- for $U_n = 500$ V: 250 A...69.4 kA
- for $U_n = 690$ V: 345 A...95.8 kA
- for $U_n = 800$ V: 400 A...111.1 kA

Display range for I_K

Display range	Resolution	Accuracy
110.0 A... 199.9 A	0.1 A	Calculated from the short-circuit accuracy
200 A...1999 A	1 A	
2.00 kA...19.99 kA	0.01 kA	
20.0 kA...199.9 kA	0.1 kA	



Prospective fault current calculated and displayed by the meter may slightly differ from the value calculated by the user with a calculator, basing on the displayed value of the impedance, because the meter calculates the current from unrounded value of fault loop impedance (which is used for displaying). As the correct value, consider I_K current value, displayed by the meter or by firmware.

Measurement of touch voltage U_{ST} (shock voltage U_T)

Display range	Resolution	Accuracy
0 V...100 V	1 V	$\pm(10\% \text{ m.v.} + 2 \text{ digits})$

- for U_T – resistor simulating electrical resistance of the human body – 1 k Ω

Maximum test current

- **230 V**: 130 A (20 ms)
- **400 V**: 220 A (20 ms)
- **500 V**: 280 A (20 ms)
- **690 V**: 190 A (20 ms)
- **800 V**: 220 A (20 ms)

13.2 Other technical data

a)	type of insulation acc. to EN 61010-1 and EN 61557	double
b)	measurement category acc. to EN IEC 61010-2-030	CAT IV 1000 V
c)	ingress protection acc. to EN 60529	
	▪ with open housing	IP20
	▪ with closed housing	IP67
d)	power supply	Li-Ion 7.2 V 9.8 Ah rechargeable battery
e)	dimensions	429 x 328 x 236 mm
f)	weight	ca. 9 kg
g)	storage temperature	-20°C...+60°C
h)	operating temperature	-10°C...+40°C
i)	humidity	20%...90%
j)	reference temperature	+23°C ± 2°C
k)	reference humidity	40%...60%
l)	rated operating altitude	≤2000 m
m)	auto-off function	10 min
n)	number of short-circuit loop measurements	min. 5000 (2 measurements/min)
o)	display	none
p)	memory of measurement results	990 results
q)	transmission of results	USB, Wi-Fi
r)	quality standard	development, design and manufacturing are ISO 9001 compliant
s)	the device meets the requirements of	EN 61557
t)	the product meets EMC requirements (immunity for industrial environment) according to the following standards	EN 61326-1, EN 61326-2-2



EN 55022 Compliance statement

MZC-340-PV is a class A product. In a domestic environment this product may cause radio interference in which case the user may be required to take adequate measures (e.g. increasing the distance between affected products).



SONEL S.A. hereby declares that the radio device type MZC-340-PV complies with Directive 2014/53/EU. The full text of the EU Declaration of Conformity is available at the following website address: <https://sonel.pl/en/download/declaration-of-conformity/>

13.3 Additional data

Data on additional uncertainties are useful mainly when the meter is used in non-standard conditions and for metrological laboratories for the purpose of calibration.

13.3.1 Additional uncertainties according to IEC 61557-3 (Z)

Significant parameter	Designation	Additional uncertainty
Position	E ₁	0%
Supply voltage	E ₂	0% (BAT is not lit)
Temperature 0°C...35°C	E ₃	0%
Phase angle 0°...30° at the bottom of test range	E _{6,2}	0.6%
Frequency 99%...101%	E ₇	0%
Network voltage 85%...110%	E ₈	0%
Harmonics	E ₉	0%
DC component	E ₁₀	0%

14 Manufacturer

The manufacturer of the device and provider of guarantee and post-guarantee service:

SONEL S.A.

Wokulskiego 11
58-100 Świdnica
Poland

tel. +48 74 884 10 53 (Customer Service)

e-mail: customerservice@sonel.com

web page: www.sonel.com



NOTE!

Service repairs must be performed only by the manufacturer.

NOTES

NOTES



SONEL S.A.

Wokulskiego 11
58-100 Świdnica
Poland

Customer Service

tel. +48 74 884 10 53
e-mail: customerservice@sonel.com

www.sonel.com